

DREMEL DIGILAB

Leveling Arm Replacement

⚠ WARNING Read the Dremel 3D45 manual and these instructions. Failure to comply with the warnings and instructions may result in fire, equipment damage, property damage, or personal injury.

Always unplug Dremel 3D45 from its power before performing any service procedures. Failure to do so may result in personal injury and equipment damage.

Use only Dremel approved materials and components. Use of object materials, or 3D objects other than Dremel approved object materials and genuine Dremel components may void warranty.

Repairs on the Dremel 3D45 may require the use of special tools (pulling devices and bearing press). Authorized repair centers have trained repair technicians and equipment necessary to perform these repairs.

For the location of the repair center near you, please look on our web site at www.Dremel3D.com and follow the link for 'Support'.

⚠ WARNING Do not touch the extruder tip or heated build platform during Dremel 3D45 operation or until it has cooled down to at least 60oC (140oF). Contact with the extruder tip or build platform during or after operation before tip and build platform has cooled may result in personal injury.

SERVICE INSTRUCTIONS

[Please click here for Video Tutorial](#)

Use proper anti-static precautions when performing this replacement. Discharge static electricity before beginning. Work on a static-free surface.

This document will outline the steps necessary to replace a defective or damaged leveling assembly. This includes the leveling switch, servo motor, and mounting bracket.

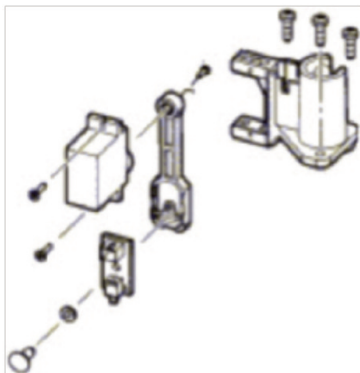

Tools Required:

- Scissors
- 2mm Hex bit or Hex wrench (Allen key)
- T10 Torx (star) or screwdriver bit

Step 1: Bring Printer to Safe State

Allow the build plate and nozzle to cool down before handling. Turn off and unplug printer then wait for 15 min to allow the nozzle and build platform to cool down to a safe temperature (below 60°C).

Step 2: Remove Top Cover on the Extruder

- a. Cut the filament just before the intake on the top of the extruder.



Figure 3: Cut filament before the intake.

- b. Remove screw located on the right side hole using the T10 Torx screwdriver. Figure 4a below shows the location of the screw, and Figure 4b shows a bottom view of the area where the screw is located. Circled in red, is the screw that needs to be removed.

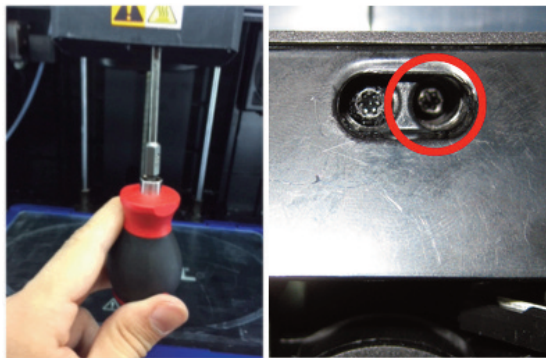

Figure 4a (Left) and 4b (Right): Remove screw located on the right side on the bottom of extruder.

- c. Unscrew the two screws on the top of the filament guide bracket using the 2.5mm Hex wrench.

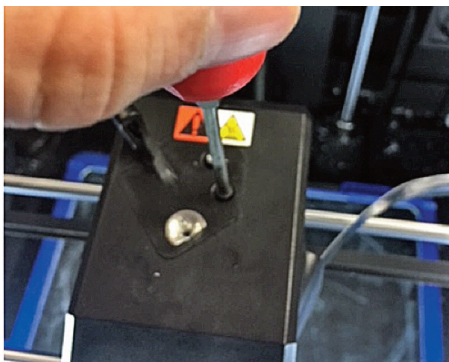

Figure 5: Extruder cover removal.

- d. Remove the top cover.
- e. Carefully unplug filament run out switch from the extruder circuit board, ensuring to pull from the plastic plug and not the wires; pulling the wires can damage the connection to the extruder.

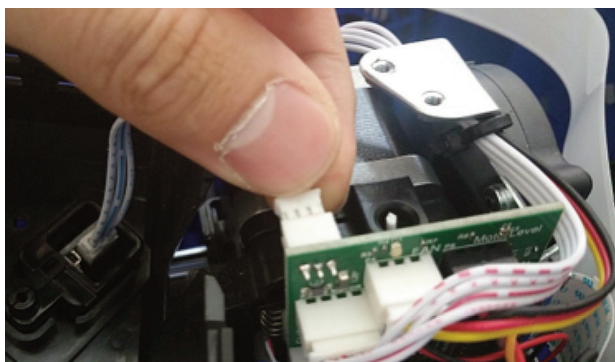

Figure 6: Runout switch being disconnected from extruder PCBA.

Step 3: Remove Shielded Circuit Cable

- a. Using the 2 black push pins (encircled red) of the shielded circuit ribbon cable, push down to release it from the circuit board.

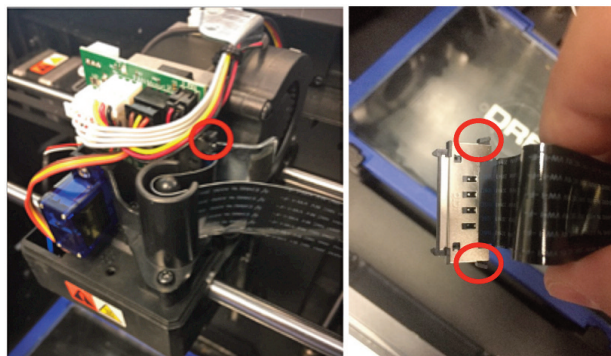

Figure 7a. 7b: Disconnect shielded circuit ribbon cable from extruder PCBA.

- b. Remove the connector from the circuit board and pull up on the cable. Always use great care when handling a shielded circuit cable.

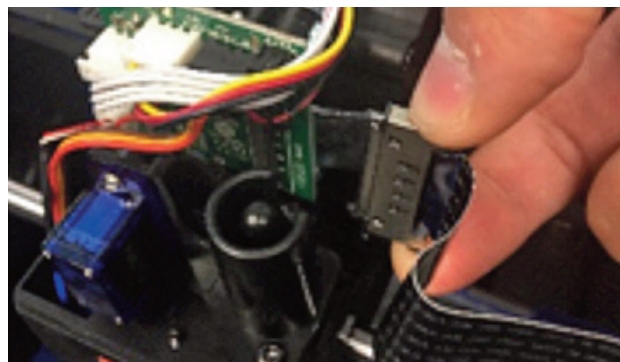

Figure 8: Removal of ribbon cable from extruder housing.

- c. Set aside the cable within the machine, making sure there are no sharp kinks or turns produced.

Step 4: Remove the Leveling Servo Assembly

- a. Remove the three screws holding the servo motor bracket in place with a T10 Torx (star) bit.

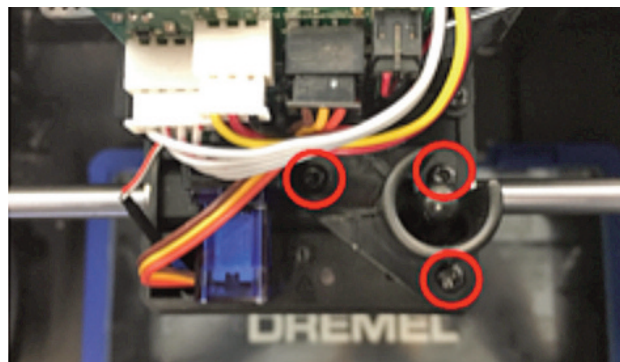

Figure 9: Unscrew servo motor levelling switch chassis.

- b. Get a visual understanding of how the levelling arm is located and oriented in the assembly, rotate the leveling arm to vertical position (see Figure 10), and then pull the servo motor assembly vertically upwards away from the extruder.

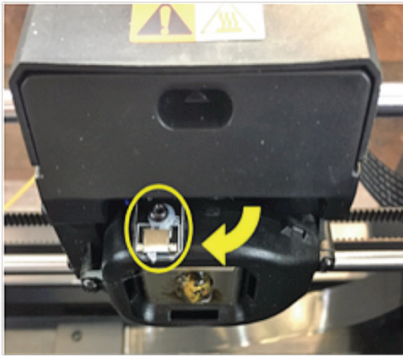

Figure 10: Rotate the levelling arm to vertical position before removing the servo motor assembly.

Step 5: Disconnect the Extruder Circuit Board

- a. Disconnect the leveling switch (black and red wires) and servo motor (red, brown, and yellow) from the extruder circuit board. When removing these, always remove by the plastic connectors. Never pull by the wires -this can damage or break the connectors.

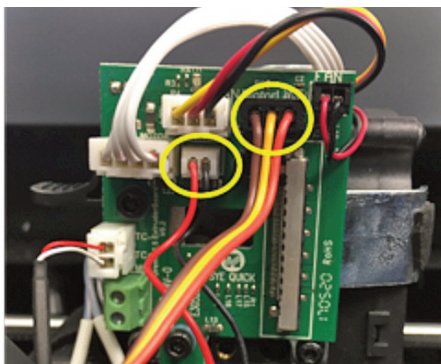

Figure 11: Disconnect encircled connectors.

Step 6: Reassemble the Extruder

- a. Replace the leveling servo assembly carefully by maneuvering the levelling arm through the extruder chassis.
- b. Replace the three screws holding the servo motor chassis in place as shown in Figure 9.
- c. Reconnect both wire connectors to the extruder circuit board as shown in Figure 11.
- d. Loop the shielded circuit cable through the plastic guide bracket. Refer Figure 8.
- e. Press the black connector pins on the shielded ribbon cables and align with the receptacle as shown in Figure 7. Gently push the ribbon cable onto the receptacle and release the black pins. An audible “click” should be heard when it is reconnected.

- f. Reconnect the filament runout switch from the extruder top cover to the circuit board. Refer Figure 6.
- g. Replace the top cover and the three (two on top, one on bottom) screws attaching it to the extruder. Refer Figure 4 and 5. NOTE: After replacing the top cover, ensure that no wires are exposed out of the extruder body. If any wires are exposed or hanging out, the extruder top cover will need to be removed and replaced.

Step 7: Calibration

This step will outline how to calibrate the leveling arm. The replaced leveling arm does not know where it is in rotation before calibration, so the following instructions will calibrate it to the correct position. Dremel will supply you with a USB stick that hosts the calibration firmware for the leveling arm.

- a. With the printer turned off, insert the supplied USB stick into the USB port on the front of your 3D45.
- b. Turn on the printer and wait for the calibration screen to appear.
- c. The “level arm set: (1/2)” will show up on the screen. The Up and Down orientations have + and - adjustment buttons. The adjusted angle can be seen in the black box between the + and - buttons.
 - i. Press “test” once to move the levelling arm down.
 - ii. Ensure the leveling arm is vertical (straight up/down) as shown in Figure 12a. If not, press + to increase angle or - to decrease angle in front of “down” as shown in Figure 12b below.

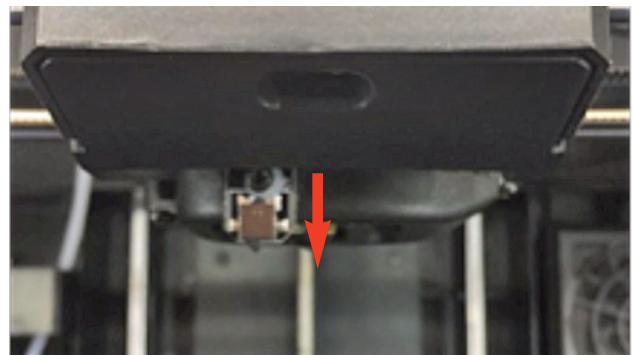

Figure 12. (a) Vertical position of leveling arm.

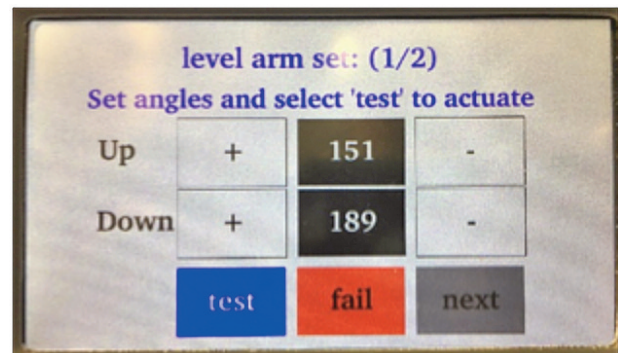

Figure 12. (b) Angle test screen.

- iii. Press “test” twice to check the orientation after adjustment in vertical position. If not satisfied with the orientation of the arm, repeat step i. and ii. until desired orientation is achieved in vertical position.
- iv. Press “test” once to move the arm in the stow position.
- v. Ensure the leveling arm is NOT exposed like it is shown in Figure 13 below.

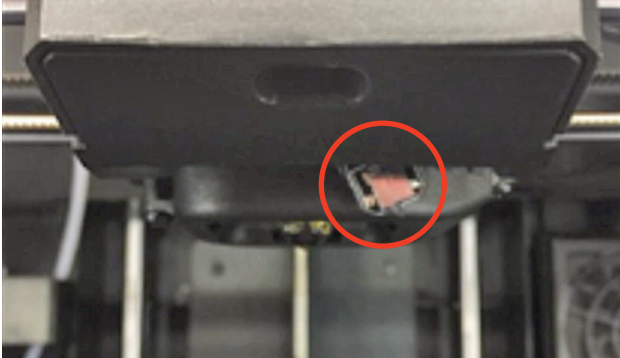

Figure 13. Exposed leveling arm in stowed position.

- vi. If yes, press - to decrease angle in front of “up”. Refer to Figure 12b.

- vii. If the arm makes a hitting sound or rebounds back while stowing, then it is stowing too high. In that case, press + to increase angle of stowing in front of “up”. The arm should be stowed as shown in the Figure 14 below, such that it doesn’t expose or rebound.

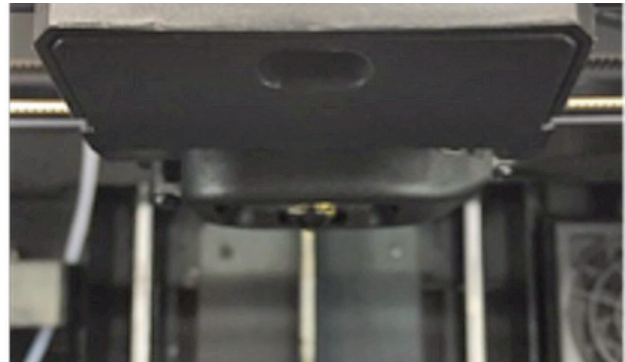

Figure 14. Leveling arm in stowed position.

- viii. Once the angles are adjusted for both vertical and stowing positions, press “next”.

Step 8: Nozzle Gap Calibration

- a. Follow Nozzle Calibration instructions.

Congratulations!
You are now ready to build. **Build On.**